

K2500 /2550 series Installation Dimensions & Tech Data

Length calculation

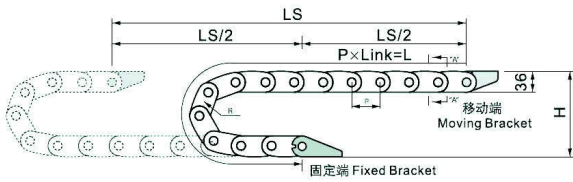

$$L = \frac{LS}{2} + \pi \times R + 180$$

L: Length
R: bending Radius
H: Installation Height
P: Pitch
180: Safety Length

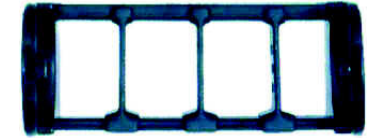
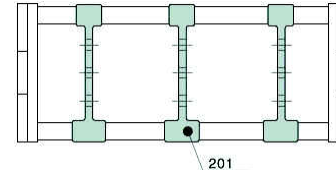
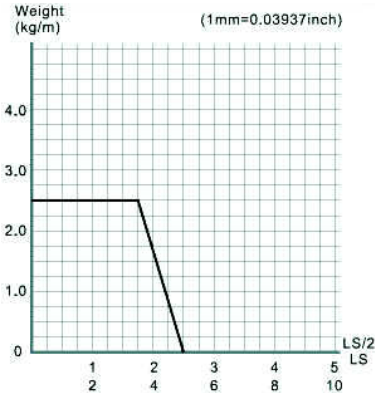

Fixed bracket

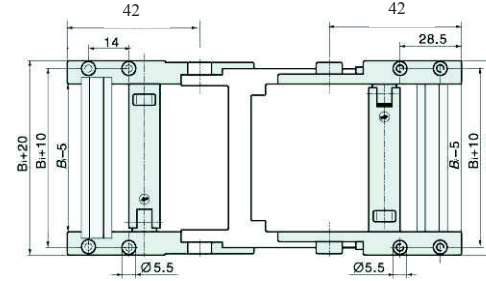

Moving bracket

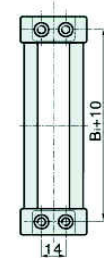

K2500 series can be open by both side

Type	Inner width (mm)	Outer width (mm)	Bending radius(mm)	Pitch (mm)
2500.040.□.0	38	54	55 75 100 125	45
2500.050.□.0	57	64	55 75 100 125	45
2500.075.□.0	77	89	55 75 100 125	45
2500.100.□.0	103	114	55 75 100 125	45

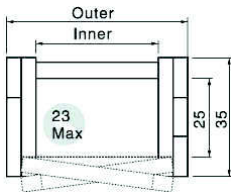

K2550 series can be open by both side

Type	Inner width (mm)	Outer width (mm)	Bending radius(mm)	Pitch (mm)
2550.038.□.0	38	54	55 75 100 125	45
2550.057.□.0	57	73	55 75 100 125	45
2550.077.□.0	77	93	55 75 100 125	45

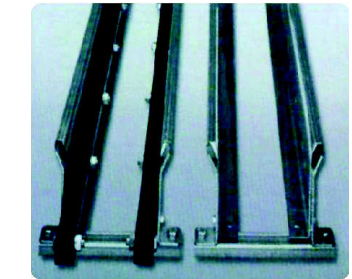
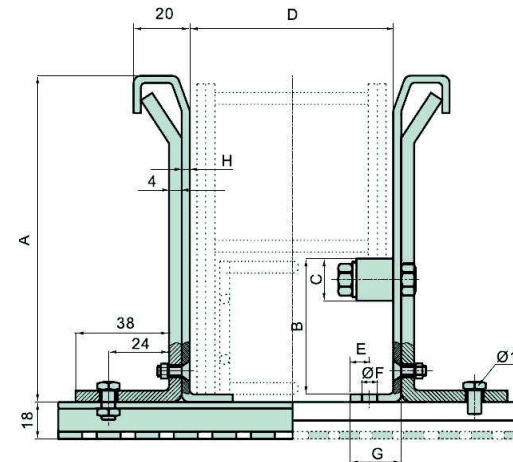
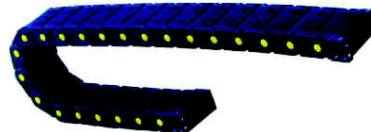
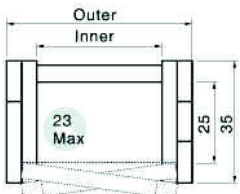

Cable tray without slide strip	1
Cable tray with slide strip	2
A	70
B	34
C	20
D	*
E	12
F	9
G	26
H	2

K3500/3550 series Installation Dimensions & Tech Data

Length calculation

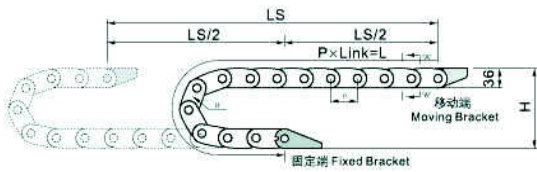

$$L = \frac{LS}{2} + \pi \times R + 224$$

L: Length
 R: bending Radius
 H: Installation Height
 P: Pitch
 224: Safety Length

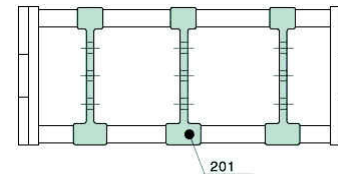
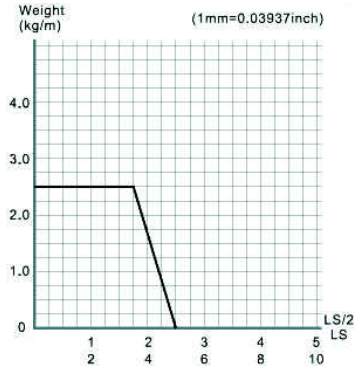

Fixed bracket

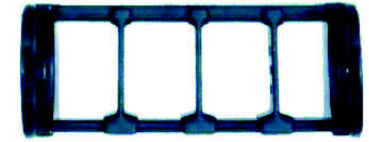
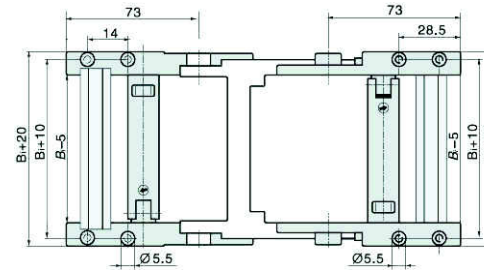

Moving bracket

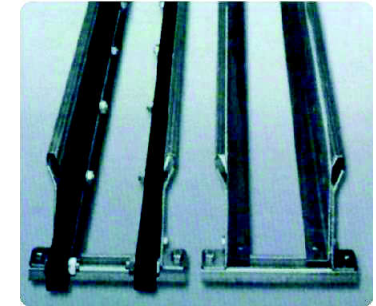
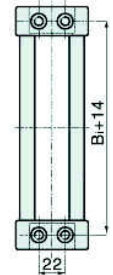

K3500 series can be open by both side

Type	Inner width (mm)	Outer width (mm)	Bending radius(mm)	Pitch (mm)
3500.050.□.0	50	77	75 100 125 150 200	45
3500.075.□.0	75	102	75 100 125 150 200	45
3500.100.□.0	100	127	75 100 125 150 200	45
3500.125.□.0	125	152	75 100 125 150 200	45
3500.150.□.0	150	177	75 100 125 150 200	45
3500.175.□.0	175	202	75 100 125 150 200	45
3500.200.□.0	200	227	75 100 125 150 200	45
3500.250.□.0	250	277	75 100 125 150 200	45

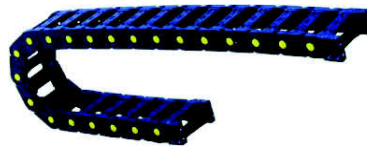
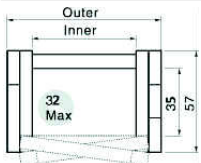

K3550 series can be open by both side

Type	Inner width (mm)	Outer width (mm)	Bending radius(mm)	Pitch (mm)
3550.050.□.0	50	77	75 100 125 150 200	45
3550.075.□.0	75	102	75 100 125 150 200	45
3550.100.□.0	100	127	75 100 125 150 200	45
3550.125.□.0	125	152	75 100 125 150 200	45

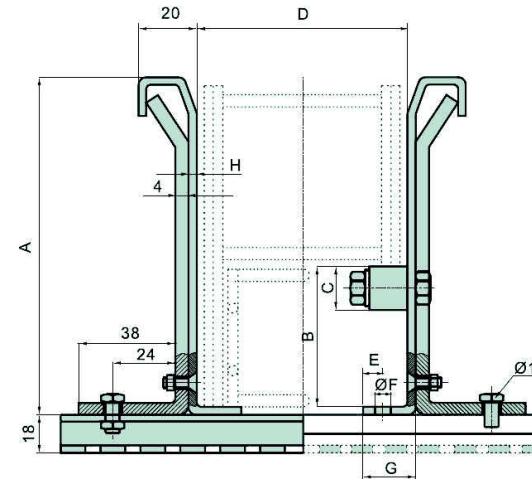
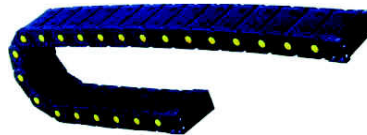
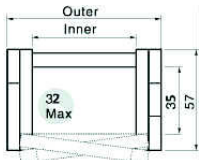

Cable tray without slide strip	1
Cable tray with slide strip	2
A	70
B	34
C	20
D	*
E	12
F	9
G	26
H	2

K3800 /3850 series Installation Dimensions & Tech Data

Length calculation

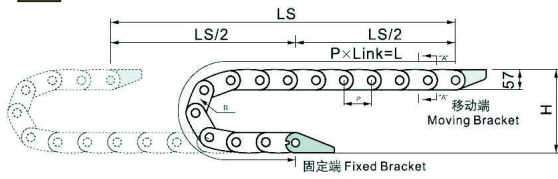

$$L = \frac{LS}{2} + \pi \times R + 224$$

L: Length
R: bending Radius
H: Installation Height
P: Pitch
224: Safety Length

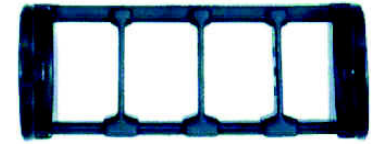
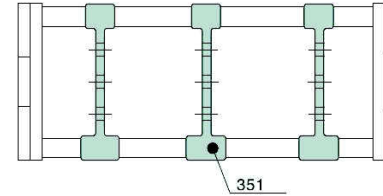
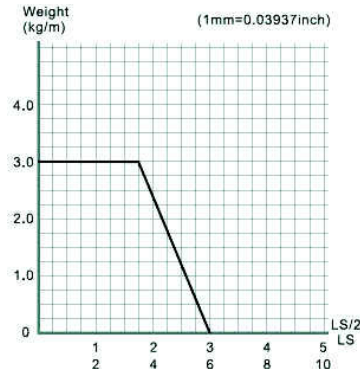

Moving bracket

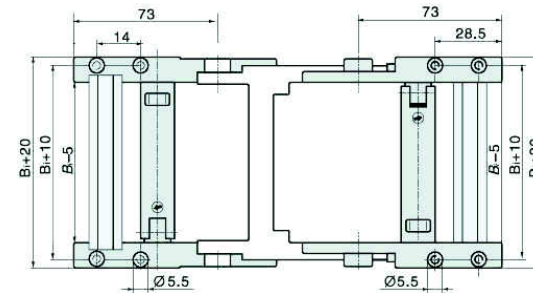

Fixed bracket

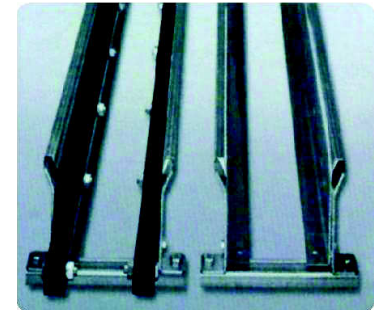
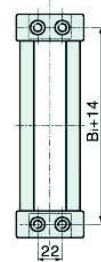

K3800 series can be open by both side

Type	Inner width (mm)	Outer width (mm)	Bending radius(mm)	Pitch (mm)
3800.050.□.0	50	77	75 100 125 150 200	45
3800.075.□.0	75	102	75 100 125 150 200	45
3800.100.□.0	100	127	75 100 125 150 200	45
3800.125.□.0	125	152	75 100 125 150 200	45
3800.150.□.0	150	177	75 100 125 150 200	45
3800.175.□.0	175	202	75 100 125 150 200	45
3800.200.□.0	200	227	75 100 125 150 200	45
3800.250.□.0	250	277	75 100 125 150 200	45

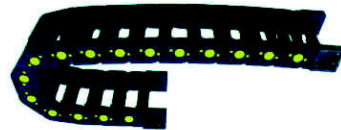
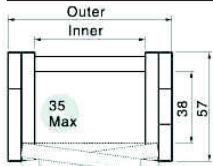

K3850 series can be open by both side

Type	Inner width (mm)	Outer width (mm)	Bending radius(mm)	Pitch (mm)
3850.050.□.0	50	77	75 100 125 150 200	45
3850.075.□.0	75	102	75 100 125 150 200	45
3850.100.□.0	100	127	75 100 125 150 200	45
3850.125.□.0	125	152	75 100 125 150 200	45

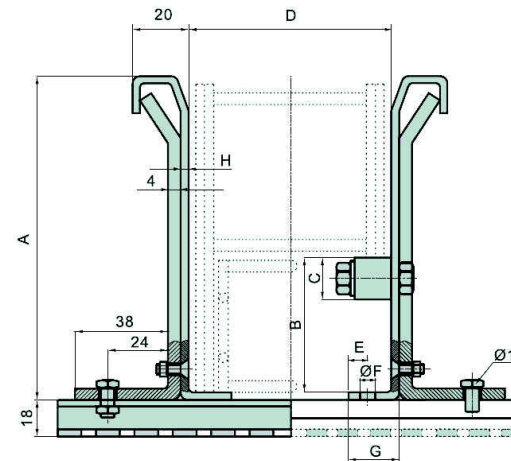
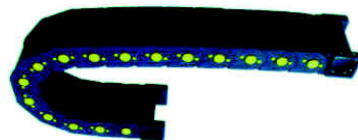
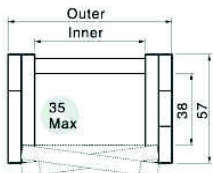

Cable tray without slide strip	3
Cable tray with slide strip	3
A	130
B	64
C	30
D	*
E	15
F	9
G	35
H	2

K4500 /4550 series Installation Dimensions & Tech Data

Length calculation

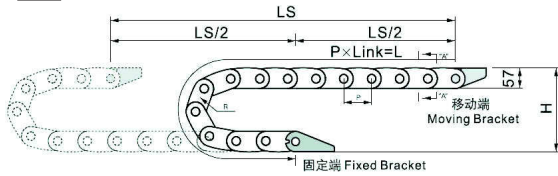

$$L = \frac{LS}{2} + \pi \times R + 268$$

L: Length
R: bending Radius
H: Installation Height
P: Pitch
268: Safety Length

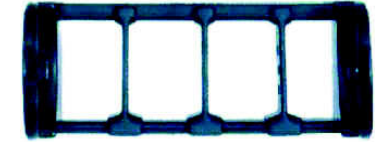
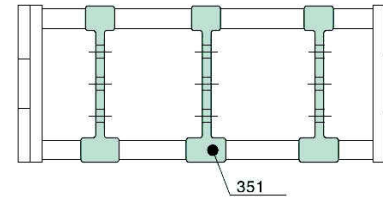
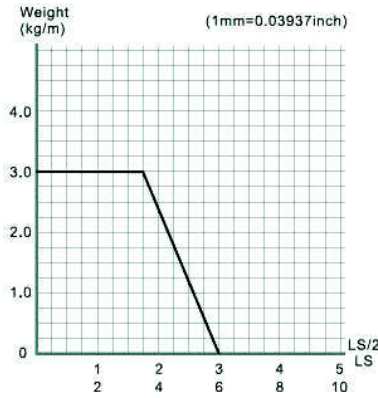

Fixed bracket

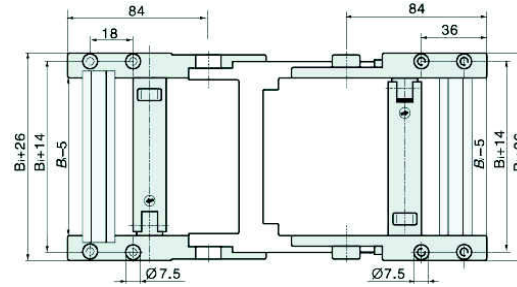

Moving bracket

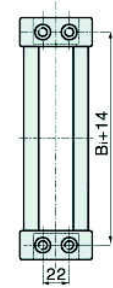

K4500 series can be open by both side

Type	Inner width (mm)	Outer width (mm)	Bending radius(mm)	Pitch (mm)
4500.050.□.0	50	77	100 125 150 200	67
4500.075.□.0	75	102	100 125 150 200	67
4500.100.□.0	100	127	100 125 150 200	67
4500.125.□.0	125	152	100 125 150 200	67
4500.150.□.0	150	177	100 125 150 200	67
4500.175.□.0	175	202	100 125 150 200	67
4500.200.□.0	200	227	100 125 150 200	67
4500.250.□.0	250	277	100 125 150 200	67

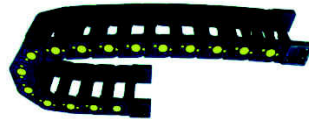
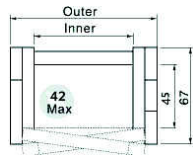

K4550 series can be open by both side

Type	Inner width (mm)	Outer width (mm)	Bending radius(mm)	Pitch (mm)
4550.075.□.0	75	102	100 125 150 200	67
4550.100.□.0	100	127	100 125 150 200	67
4550.125.□.0	125	152	100 125 150 200	67

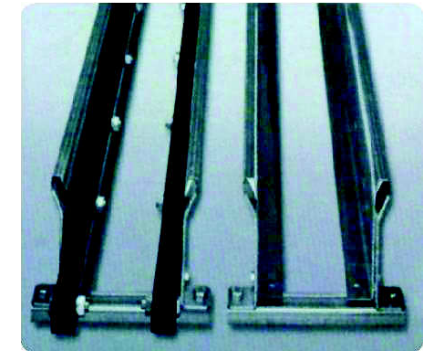
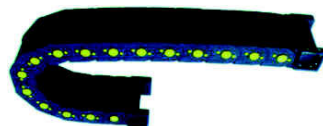
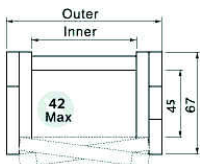

Cable tray without slide strip	3
Cable tray with slide strip	3
A	130
B	64
C	30
D	*
E	15
F	9
G	35
H	2



