

# K5500/5550 series Installation Dimensions & Tech Data

## Length calculation

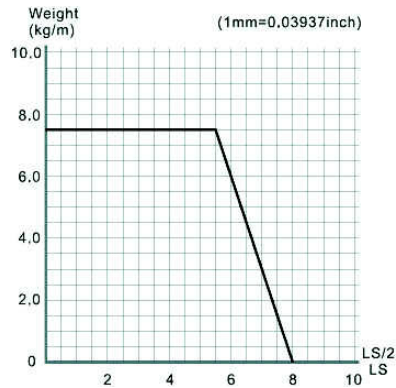
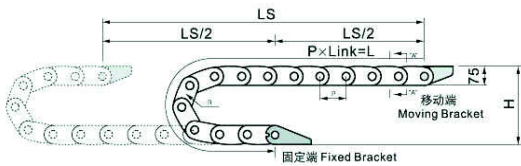

$$L = \frac{LS}{2} + \pi \times R + 364$$

L: Length  
 R: bending Radius  
 H: Installation Height  
 P: Pitch  
 364: Safety Length

## K5500 series can be open by both side

Type	Inner width (mm)	Outer width (mm)	Bending radius(mm)	Pitch (mm)
5500.100.□.0	100	127	150 200 250 300 350	91
5500.125.□.0	125	152	150 200 250 300 350	91
5500.150.□.0	150	177	150 200 250 300 350	91
5500.175.□.0	175	202	150 200 250 300 350	91
5500.200.□.0	200	227	150 200 250 300 350	91
5500.250.□.0	250	284	150 200 250 300 350	91
5500.300.□.0	300	334	150 200 250 300 350	91
5500.350.□.0	350	384	150 200 250 300 350	91
5500.400.□.0	400	434	150 200 250 300 350	91

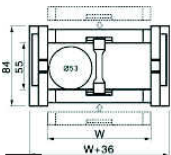

## K5550 series can be open by both side

Type	Inner width (mm)	Outer width (mm)	Bending radius(mm)	Pitch (mm)
5550.100.□.0	100	127	150 200 250 300 350	91
5550.125.□.0	125	152	150 200 250 300 350	91
5550.150.□.0	150	177	150 200 250 300 350	91

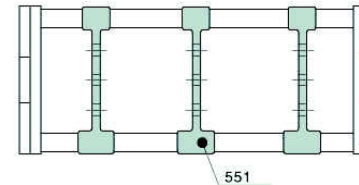
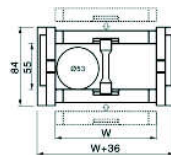

## Fixed bracket

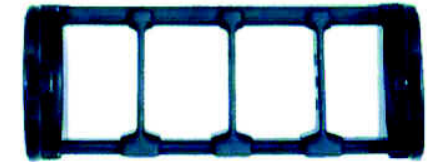
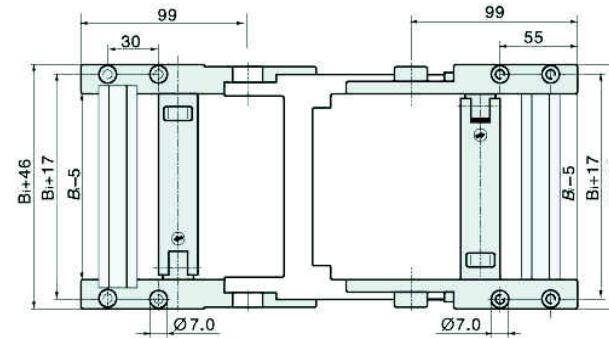

## Moving bracket

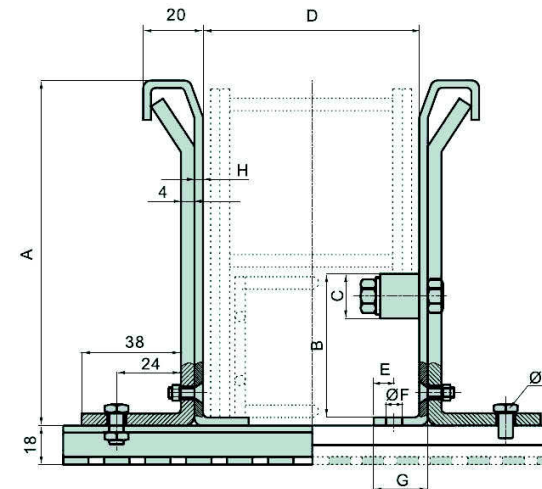
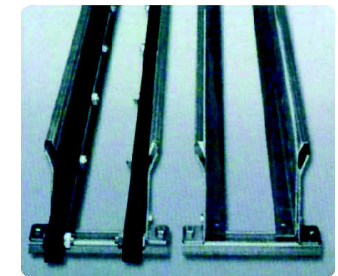
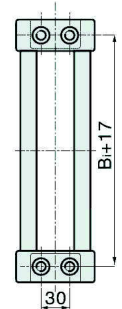

Cable tray without slide strip	1
Cable tray with slide strip	2
A	170
B	84
C	30
D	*
E	20
F	11
G	50
H	2